



The park

Mimi's kite



Listen, point and repeat. Listen and stick the park stickers. Listen and play *Memory*. Circle the things in your park. Say. **Language:** bench, pond, roundabout, seesaw, slide, swing; blue, green, orange, pink, red, yellow; Where's the (seesaw)? It's on (pink).

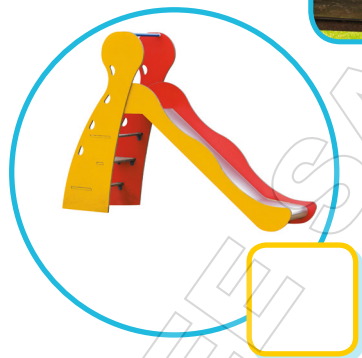
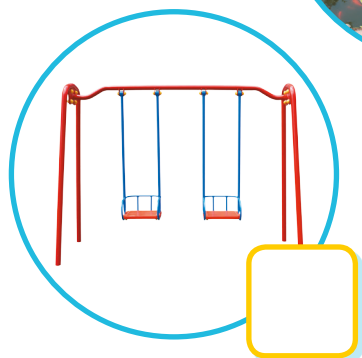
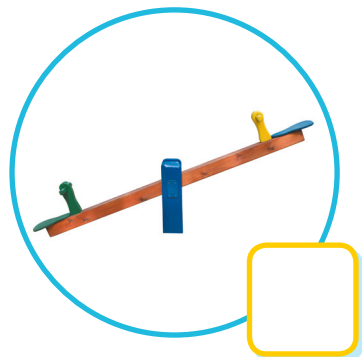

Listen and find the new park words. Listen, point and sing *There's a pond in the park*. Tick (✓) the park objects in the song. Say. **Language:** bench, flowers, grass, path, pond, roundabout, seesaw, slide, swings, trees; There's (a pond). There are (trees).



Find and circle five differences. Point and say.

Language: bench, flowers, grass, path, pond, roundabout, seesaw, slide, swings, trees; There's (a pond). There are (trees).

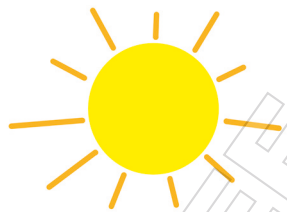

Watch. Listen to the story *Mimi's kite*. Circle the weather in the story. Stick the story sticker.

Language: bench, flowers, kite, path, pond, slide, swings, trees, windy; It's (windy). There's the (pond). There are the (flowers). Is there (a slide)? Are there (swings)? Where's (Mummy)? Under the (tree). On the (bench).



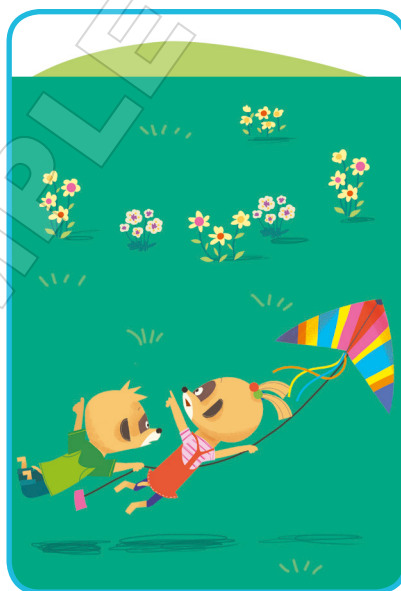

Watch. Listen, point and sing *Fly the kite*. Trace the numbers. Match the numbers and pictures in order. Say. **Language:** flowers, kite, pond, trees; numbers 1–4; There's the (pond). There are the (trees).



The park

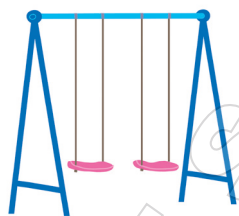

Watch. Listen and point. Circle what's in the park. Ask and say. **Language:** bench, flowers, grass, path, pond, roundabout, seesaw, slide, swings, trees; Is there (grass)? Are there (trees)? There's (a roundabout). There are (swings).





Listen, point and sing *Put your rubbish in the bin*. Trace and colour the bin green. Find the rubbish and draw lines to the bin. Say. **Language:** bin, clean, park, rubbish; Put your (rubbish) in the (bin). I put my rubbish in the bin.



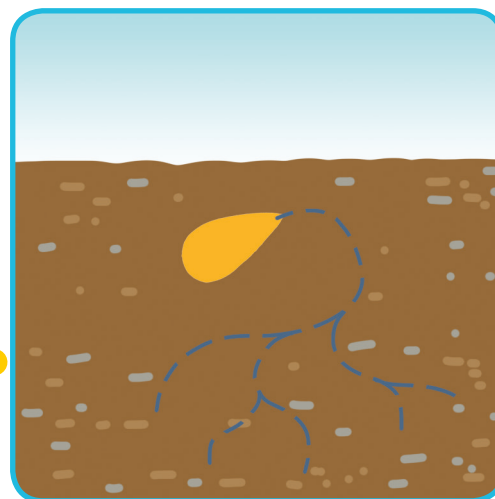
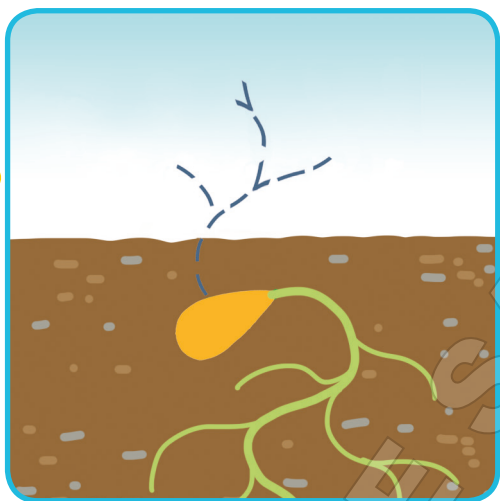
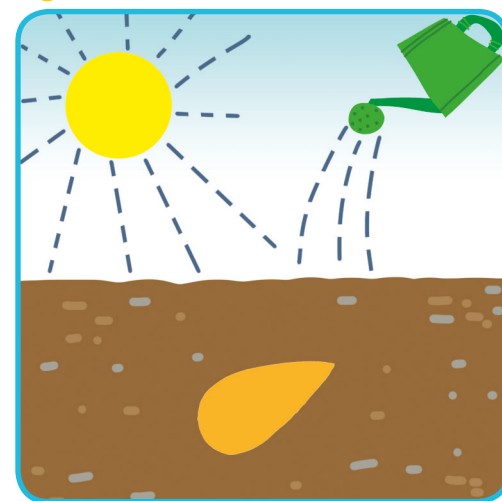
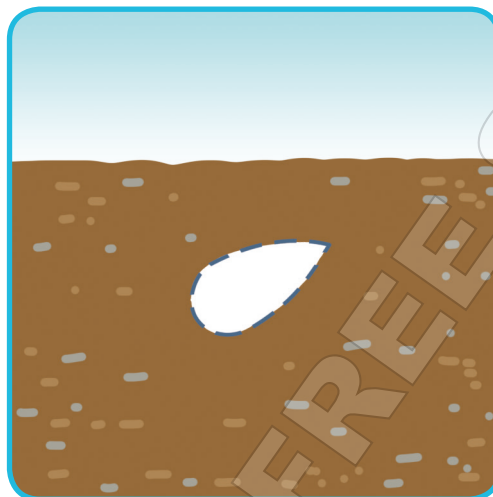
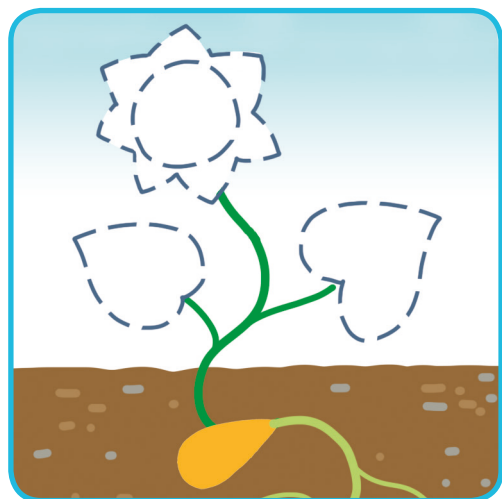

Listen and point. Trace and colour the pictures to show the life cycle of a plant.

Language: flower, leaves, plant, roots, seed, sun, water; There's (a seed). There are (leaves).



Watch. Listen and point to the story *Little Red Riding Hood*. Circle the words you hear in the story. Say. **Language:** apples, biscuits, cake, ears, eyes, flowers, house, path, teeth, trees, wolf; There are (trees).





Review

The park

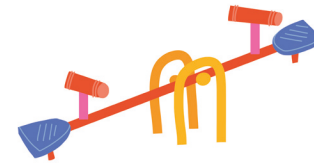
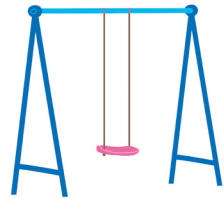
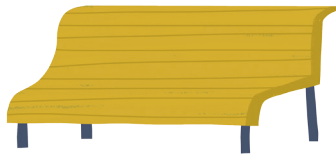
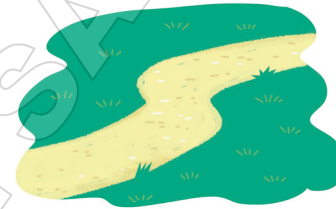
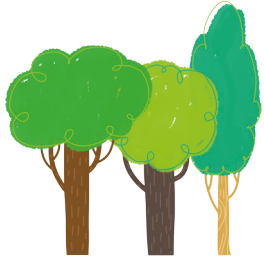

I can ...

Vocabulary



Story



Speaking



Content



1:49 1:50

hello

Circle the park words you know. Listen, point and say. Listen and answer. Ask and say. Complete the faces to show what you can do. **Language:** bench, flowers, grass, path, pond, roundabout, seesaw, slide, swing, trees; What's in the park? There's (a pond). There are (flowers).

Project



The park

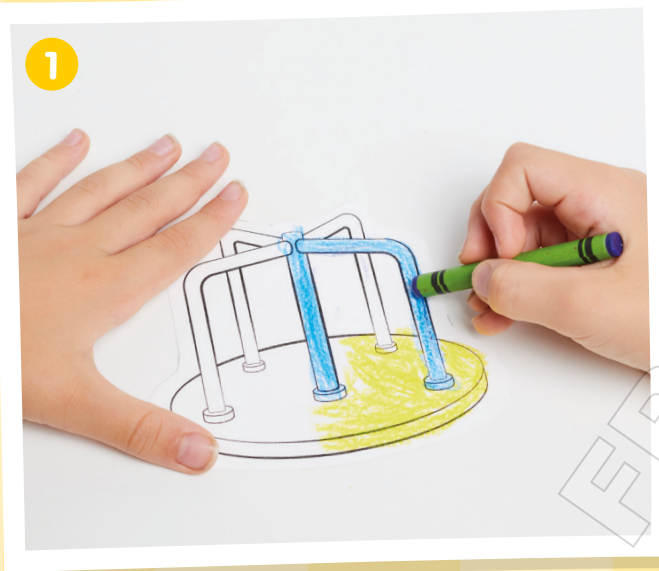
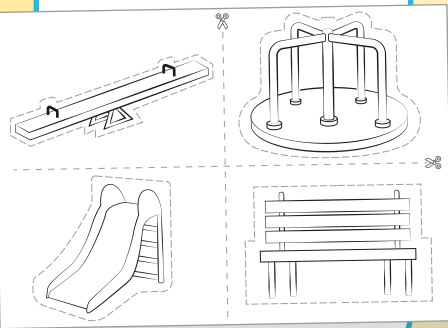
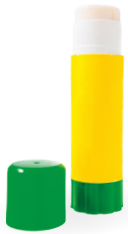

Choose and colour an object for the park. Make a poster of your ideal park. Ask and say.
Language: bench, roundabout, seesaw, slide; colours; There's a (slide). There are (seesaws).
My (seesaw) is (red). I like the (slide). Do you like the (slide)? Yes. / No.